

Ficha Técnica



CREE
LEDs
SMD2835

CÓDIGO	POTÊNCIA	LM	TENSÃO
5620001CW	200w	27000lm	170-260v

ESPECIFICAÇÕES TÉCNICAS

Ângulo de abertura	120°
Temperatura de Cor	6000k
IRC	>80
LED Chip	SMD 2835
Proteções Driver	OVP/SCP/OPP/OTP
Temperatura de trabalho	-20°/50°
Material	Aluminio + vidro
Acabamento	Preto
Dimensões	375x375x88mm
Certificados	CE&Rohs

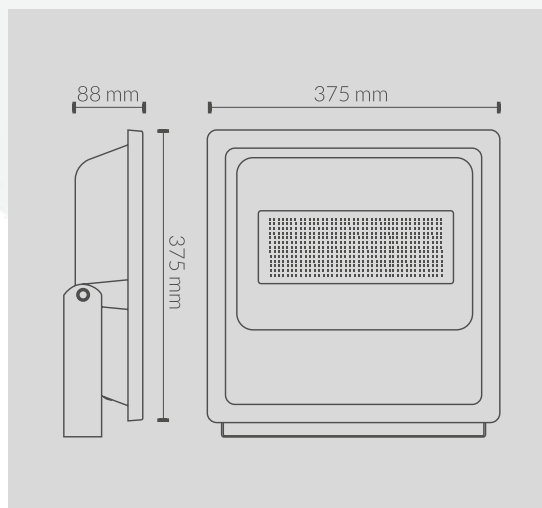

PROTECCIONES DEL DRIVER

PROTEÇÕES DO DRIVER

OVP	Protección contra sobretensión <i>Proteção contra sobretensão</i>
SCP	Protección contra cortocircuitos <i>Proteção contra curto-circuito</i>
OPP	Protección de sobrecarga <i>Proteção de sobrecarga</i>
OTP	Protección contra sobrecalentamiento <i>Proteção contra superaquecimento</i>